



Bedienungsanleitung /
Operating instructions /
Mode d'emploi

V9406

Verafix-Cool

Verafix-Cool

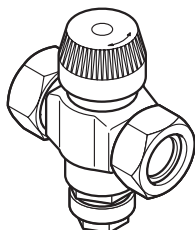

Zubehör /
Accessories /
Accessoires



Löttülle (Messing) /
Soldering tailpiece (brass) /
Douille à braser (laiton)
Schweißtülle (Stahl) /
Welding tailpiece (steel) /
Douille à souder (acier)
Gewindetülle (Messing) /
External thread tailpiece (brass) /
Douille filetée (laiton)

A Dichtung einsetzen /
Fit sealing /
Raccordement

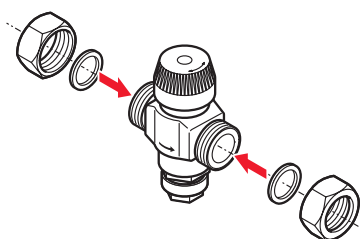

! Montage im Rücklauf / Installation in return /
Montage sur le retour

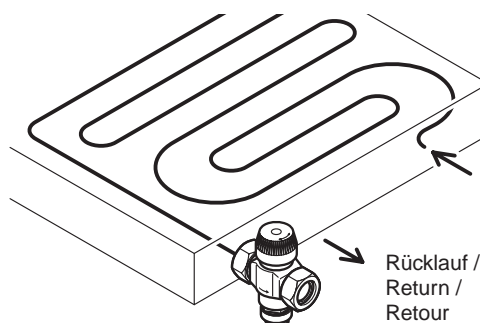

Vorlauf /
Supply /
Départ

Rücklauf /
Return /
Retour

B Voreinstellen / Pre-setting / Pré-réglage

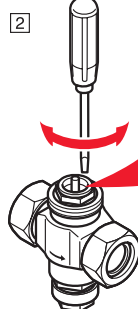
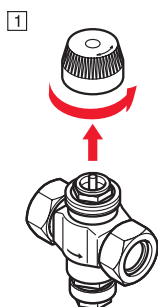

Werkseinstellung = 20.
Auf gewünschte Voreinstellung
zurückdrehen /
Factory setting = 20.
Turn back to required pre-setting /
Réglage d'usine = 20.
Tournez dans le sens antihoraire
pour changer le réglage

1 x = 10

2 x = 20

20 = offen /
open / ouvert

1 x = 10 2 x = 20

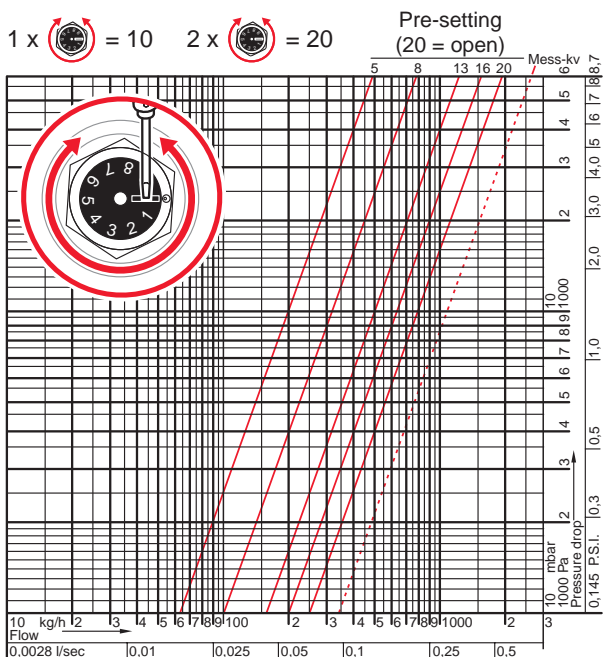

C Absperren / Shutoff /
Fermeture

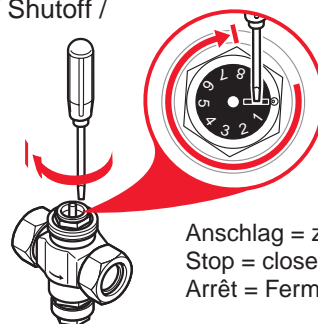

Anschlag = zu /
Stop = closed /
Arrêt = Fermeture

Für längerfristige
Absperrung Bautenschutzkappe verwenden /
Use protection cap for longer-term shutoff /
Pour fermeture de longue durée utilise
capot de protection

Voreinstellung / Pre-setting / Pré-réglage	5	8	13	16	20=open
kv-Wert / kv-value / valeur kv	0,63	1,00	1,60	2,00	2,50
cv-Wert / cv-value / valeur cv	0,73	1,16	1,86	2,33	2,91



Bedienungsanleitung /
Operating instructions /
Mode d'emploi

V9406 Verafix-Cool

D Füllen und Entleeren / Filling and draining / Remplissage et vidange

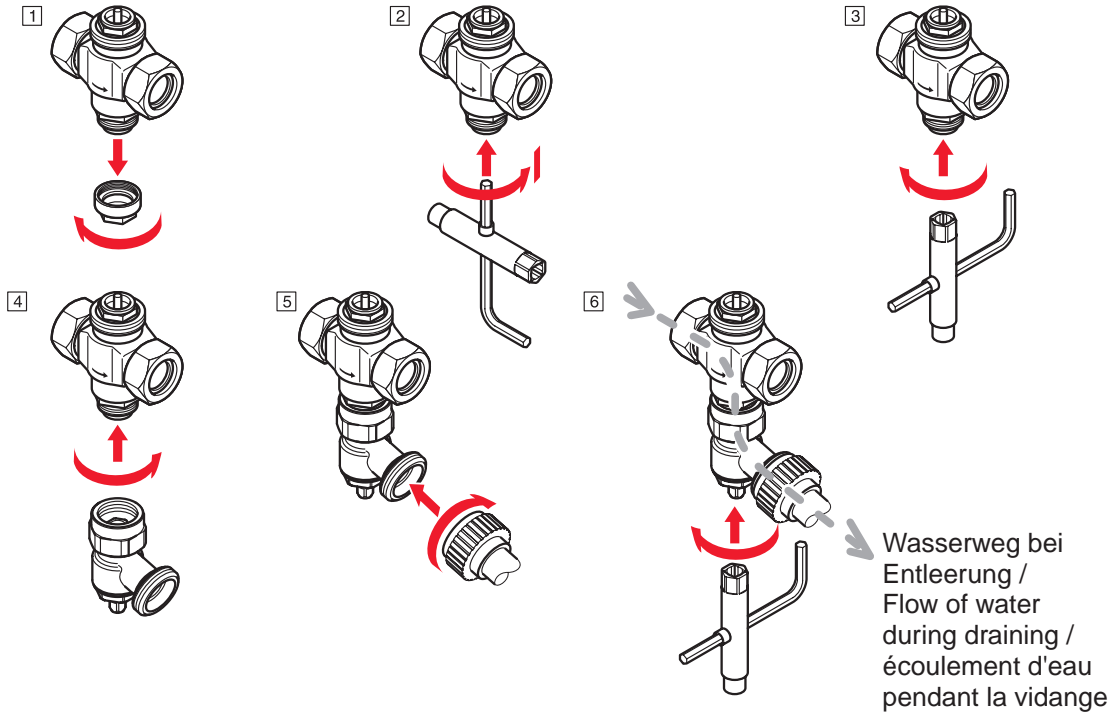

E Messen und Regeln / Measuring and pre-setting / Mesure et réglage

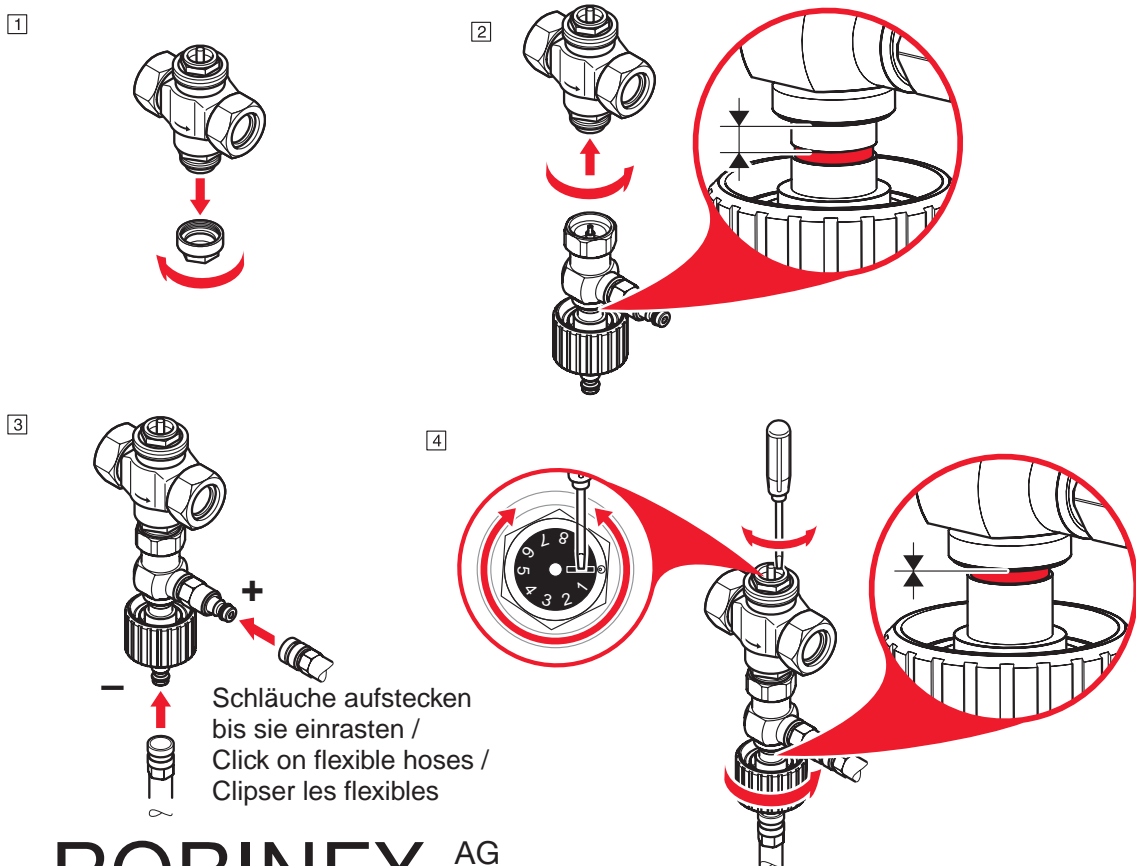

ROBINEX AG
SA